

NOTES: MATERIAL & FINISH
 1.INSULATOR: HIGH-TEMP THERMOPLASTIC, UL94V-0
 COLOR: WHITE
 2.CONTACT: COPPER ALLOY
 3.PLATING: TIN FLASH OVERALL NICKEL
 UNDER PLATED
 4.ORDER INFORMATION: 4509K-X XX N-01 X

△ L: PAPER REEL
 △ R: PLASTIC REEL
 △ E: TUBE
 △ D: TRAY AND HUMIDITY LABEL

PIN.	A	B	C	D
02	2.00	8.00	5.00	6.50
03	4.00	10.00	7.00	8.50
04	6.00	12.00	9.00	10.50
05	8.00	14.00	11.00	12.50
06	10.00	16.00	13.00	14.50
07	12.00	18.00	15.00	16.50
08	14.00	20.00	17.00	18.50
09	16.00	22.00	19.00	20.50
10	18.00	24.00	21.00	22.50
11	20.00	26.00	23.00	24.50
12	22.00	28.00	25.00	26.50
13	24.00	30.00	27.00	28.50
14	26.00	32.00	29.00	30.50
15	28.00	34.00	31.00	32.50
16	30.00	36.00	33.00	34.50

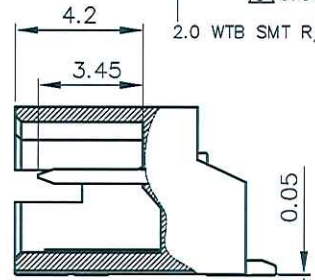
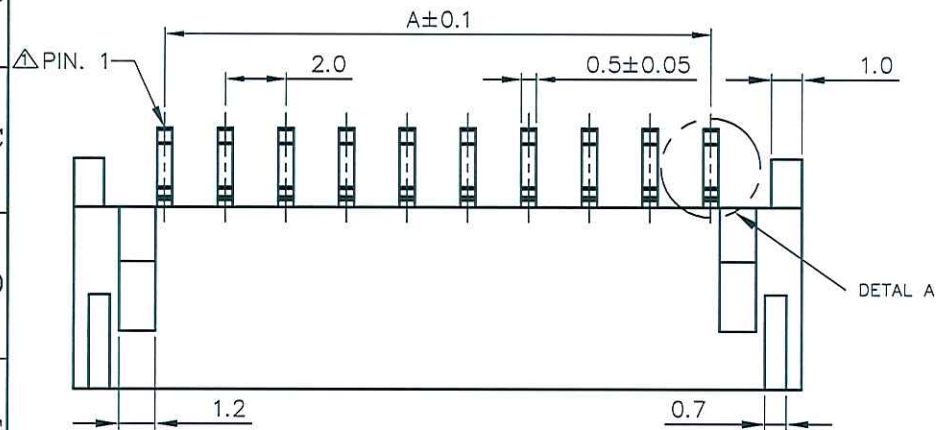

ENTERY INDUSTRIAL CO., LTD.
 APR - 1 2014
 R&D D.C.C. ISSUED

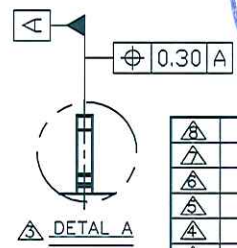
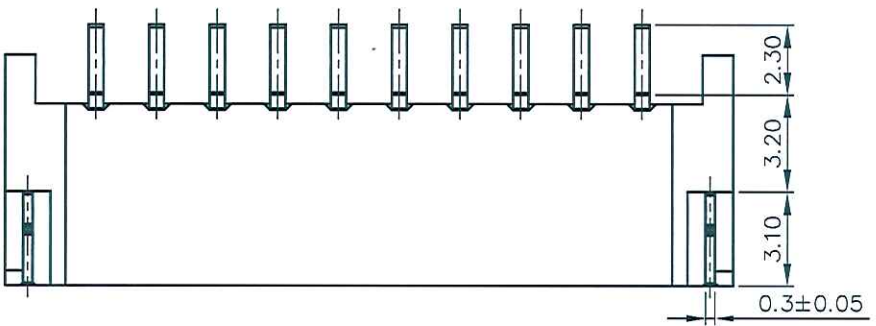
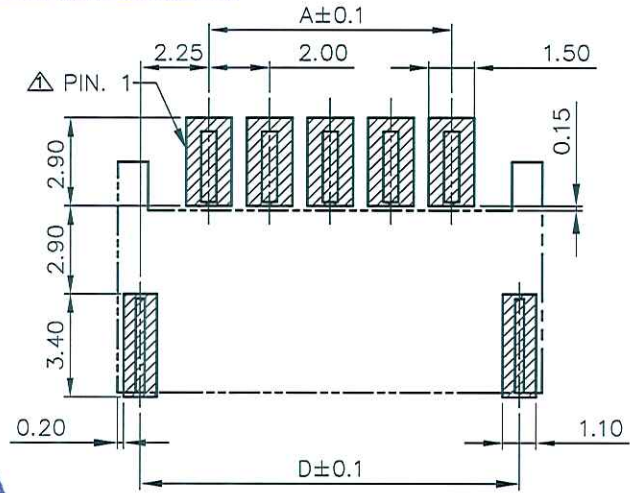
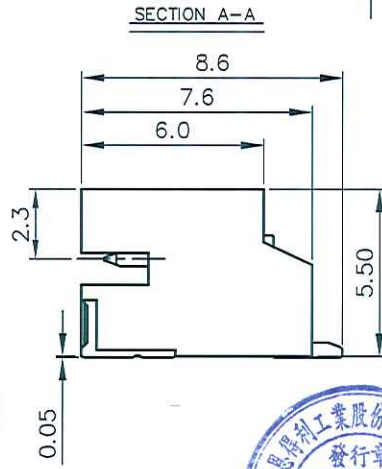
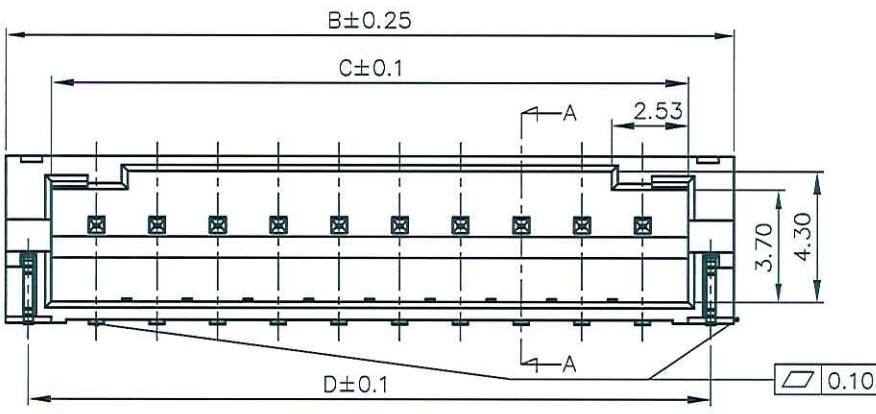

RECOMMEND P.C.B LAYOUT
 TOLERANCE : ±0.05

CUSTOMER	E & T 恩得利工業股份有限公司 ENTERY INDUSTRIAL CO., LTD.	
	DRAWN Ben Aug-04-2005	PART NO. △ 4509K-XXXN-01X
SER	REVISIONS	DATE
	CHK	DATE
GENERAL TOLERANCE UNLESS OTHERWISE SPECIFIED		TITLE: 2.0 WTB SMT R/A TYPE SINGLE ROW
X.X ±0.30		UNIT MM
X.XX ±0.20		SCALE 4:1
X.XXX ±0.10		SIZE A4
ANG. ±0'30'		REV I
SHEET	1/1	

△	RE201210002 RE201206014	MAX	12/19/12
△	REN101201	JIMMY	12/01/10'
△	RE201008034	MAX	09/03/10'
△	REN90604	JOHN	06/04/09'
△	RE070123	JOAN	02/01/07'
△	REN61103	ALICE	11/02/06'