

**TO**

---

**SPECIFICATION FOR APPROVAL**

DESCRIPTION: Pitch 1.5mm Board To Board Connector, R/A ,SMT Type

---

CUSTOMER PROD.NO/DWG.NO:

---

E&T PROD.NO: 1151K-XXXXF-00X

---

APPROVAL SHEET NO:

---

E&T DWG. NO./DOCUMENT: 1151K-XXXXF-00X

---

REV: A3

**PLEASE RETURN TO US ONE COPY OF "SPECIFICATION FOR APPROVAL" WITH YOUR APPROVED SIGNATURES.**

<b>APPROVED SIGNATURES</b>			



**ENTERY INDUSTRIAL CO., LTD.  
E&T ELECTRONICS (DONG GUAN) CO., LTD.  
E&T ELECTRONICS (SU ZHOU) CO., LTD.**

# ENTERY INDUSTRIAL CO., LTD.

## PRODUCT SPECIFICATION

### 1. SCOPE :

This specification covers the 1.5 WTB Connector series.

Including part number

Part Number	Title
1151K-XXXF-00X	1.5 Board To Board R/A , SMT

### 2. RATINGS :

Item	Standard	
Rated Current	1.0A	AC(rms)/DC
Rated Voltage	150V	
Operating and Non-operating Temperature Range	-40 <sup>0</sup> C ~ +105 <sup>0</sup> C*	
Operating and Non-operating Humidity Range	40%~80%	
Storage Temperature Range	-10 <sup>0</sup> C ~ +50 <sup>0</sup> C*	
Storage Humidity Range	40%~70%	

\*Includes temperature rise caused by current flow.

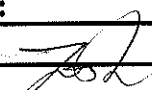
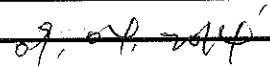
REV	Revisions	Date	Series: 1.5 Pitch Wire To Board Connector
A3	RE201408007	2014/9/1	
Document No.			Created/Revised : Juno May-31-2012
1151K-XXXF-00X			Checked : 
			Approved : 

# ENTERY INDUSTRIAL CO., LTD.

## PRODUCT SPECIFICATION

### 3.PERFORMANCE :

#### 3- 1 Electrical Performance

Item		Test Condition	Requirement
3-1-1	Contact Resistance	Mate connectors, measure by dry circuit, 20Mv MAX . 10Ma EIA-364-06C	20M $\omega$ (Max)
3-1-2	Insulation Resistance	Apply 500V $\pm$ 10% DC between adjacent terminals, or terminal and ground. EIA-364-21D	100M $\Omega$ (Min)
3-1-3	Withstanding Voltage Test	Apply 500V AC (rms) for 1 minute between adjacent terminals, or terminal and ground. EIA-364-20D	No Breakdown

#### 3-2 Mechanical Performance

Item		Test Condition	Requirement
3-2-1	Mating and Un mating Force Test	Mating and un mating connectors at the speed rate of 25 $\pm$ 3mm/minute. EIA-364-13D	See-4-1
3-2-2	Pin Retention Force	Apply axial pull out force at the speed rate of 25 $\pm$ 3 mm/minute on the terminal assembled in the housing. EIA-364-29C	0.3kgf (Min)
3-2-3	Fitting Nail/ Housing Retention Force	Apply axial pull out force at the speed rate of 25 $\pm$ 3 mm/minute on the fitting nail assembled in the housing. EIA-364-29C	0.2kgf (Min)
3-2-4	Durability	When mated up to 30 cycles repeatedly by the rate of 10 cycles/minute. EIA-364-09C	Withstanding Voltage : Meet 3-1-3
			Insulation esistance : $\geq$ 10M $\Omega$
			Contact Resistance $\leq$ 40M $\omega$

# ENTERY INDUSTRIAL CO., LTD.

## PRODUCT SPECIFICATION

### 3-3 Environmental Performance and Others

Item		Test Condition	Requirement
3-3-1	Vibration	Mate connectors and subject to the following vibration conditions, for a period of 2 hours in each of 3 mutually perpendicular axes, passing DC 1Ma during the test. Amplitude : 1.52mm P-P Frequency : 10-55-10 Hz Shall be traversed in 1 minute. EIA-364-28E	Appearance No Damage
			Contact Resistance $\leq 40M\omega$
			Discontinuity 1μsec MAX
3-3-2	Temperature Life Test (Heat Resistance)	Mate connectors and expose to $85\pm 2^{\circ}C$ for 96 hours. Upon completion of the exposure period, the test specimens shall be conditioned at ambient room conditions for 1 to 2 hours, after which the specified measurements shall be performed. EIA-364-17B	Appearance No Damage
			Contact Resistance $\leq 40M\omega$
3-3-3	Thermal Shock (Temperature Cycling Test)	Mate connectors and subject to the following conditions for 5 cycles. Upon completion of the exposure period, the test specimens shall be conditioned at ambient room conditions for 1 to 2 hours, after which the specified measurements shall be performed. 1 cycle a) $-55 +0/-3^{\circ}C$ , 30 minutes(Min) b) $25 +10/-5^{\circ}C$ , 5 minutes(Max) c) $85 +3/-0^{\circ}C$ , 30 minutes(Min) d) $25 +10/-5^{\circ}C$ , 5 minutes(Max) EIA-364-32E	Appearance No Damage
			Contact Resistance $\leq 40M\omega$
3-3-4	Cold Resistance (Low Temperature Test)	Mate connectors and expose to $-40\pm 3^{\circ}C$ for 96 +5/-0 hours. Upon completion of the exposure period, the test specimens shall be conditioned at ambient room conditions for 1 to 2 hours, after which the specified measurements shall be performed. EIA-364-59A	Appearance No Damage
			Contact Resistance $\leq 40M\omega$
3-3-5	Humidity	Mate connectors and expose to $40\pm 2^{\circ}C$ , relative humidity 90 to 95% for 96 hours. Upon completion of the exposure period, the test specimens shall be conditioned at ambient room conditions for 5 hours, after which the specified measurements shall be performed. EIA-364-31B	Appearance No Damage
			Withstanding Voltage : Meet 3-1-3
			Insulation esistance : $\geq 10M\Omega$
			Contact Resistance $\leq 40M\omega$

# ENTERY INDUSTRIAL CO., LTD.

## PRODUCT SPECIFICATION

### 3-3 Environmental Performance and Others

Item		Test Condition	Requirement
3-3-6	Resistance To Soldering Heat	Soldering iron method Solder Time : 3±0.5 sec Solder Temperature: 350±10℃ However, without too much pressure to the terminal pin. EIA-364-56D	Appearance No Damage
		Using the reflow profile condition below paragraph 5-1. The product was reflowed two times.	Appearance No Damage
3-3-7	Steam Aging	Steam Aging Temperature : 98±2 °C Duration: 8 hours±5 minutes Solder Temperature : 245±3 °C	Appearance No Damage
3-3-8	Solder Ability	Soldering Time : 3±0.5 sec EIA-364-52A	Solder Wetting : 95% Of Immersed Area Must Show No Voids, Pin Holes
3-3-9	Salt Spray	Mate connectors and expose to the following salt mist conditions. Upon completion of the exposure period, salt deposits shall be removed by a gentle wash or dip in running water, after which the specified measurements shall be performed. NaCl solution : 5 % Ambient temperature : 35+1/-2℃ Spray time : 48 hours This test only gold-plated products EIA-364-26B	Appearance No Damage
			Contact Resistance ≤ 40M ω
3-3-10	Temperature Rise Test	Carrying rated current load. EIA-364-70B	Temperature Rise : 30 °C (MAX)
3-3-11	Mechanical Shock (Physical Shock)	Mate connectors and subject to the following shock conditions. 3 shocks shall be applied along 3 mutually perpendicular axes, passing DC 1 Ma current during the test. (Total of 18 shocks) Test pulse : Half Sine Peak value : 490 m/s <sup>2</sup> {50 G} Duration : 11 ms EIA-364-27B	Appearance No Damage
			Contact Resistance ≤ 40M ω
			Discontinuity 1μsec MAX
3-3-12	SO <sub>2</sub> Gas Mixed Flowing GAS Test	24 hours exposure to 50±5ppm. SO <sub>2</sub> gas at 40±2℃ EIA-364-65A	Appearance No Damage
			Contact Resistance ≤ 40M ω
3-3-13	NH <sub>3</sub> Gas Mixed Flowing GAS Test	40 minutes exposure to NH <sub>3</sub> gas evaporating from 28% Ammonia solution. EIA-364-65A	Appearance No Damage
			Contact Resistance ≤ 40M ω

**ENTERY INDUSTRIAL CO., LTD.****PRODUCT SPECIFICATION**

4-1

Unit:kgf

Pin No.	At Initial		At 30 <sup>th</sup>
	I.F(MAX)	W.F(Min)	W.F(Min)
3	3	0.3	0.3
6	3	0.6	0.6

# ENTERY INDUSTRIAL CO., LTD.

## PRODUCT SPECIFICATION

### 5-1 Infrared Reflow Condition

- 1) Ascending time to preheating temperature 170°C shall be 40 seconds minimum.
- 2) Preheating shall be fixed at 160...180°C for 60...90 seconds.
- 3) Heating shall be fixed at 220°C for 50...60 seconds.
- 4) At 260±5°C peak shall be 10 seconds maximum.

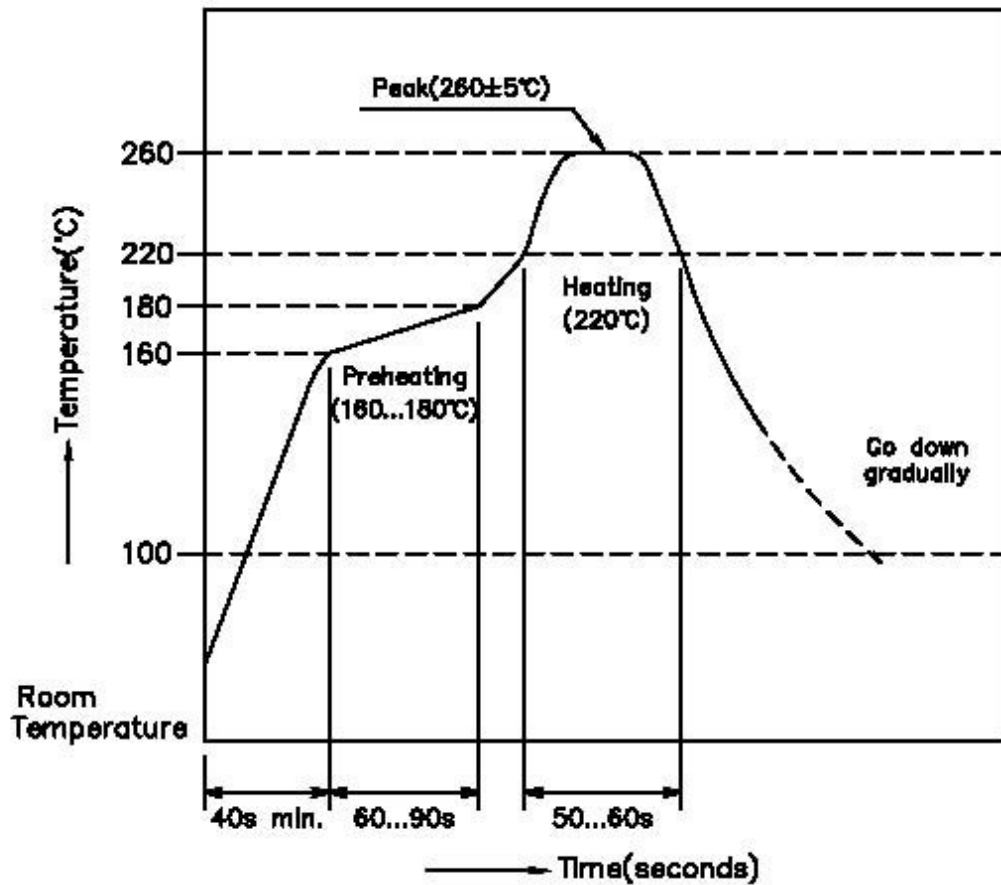





## Board To Board Handling Precautions

This manual is to describe basic precautions. When there are doubtful points in use of, please contact E&T.

### 1. Common Handling Precautions

- Do not expose E&T's wire to board connector, processing process product and processing product to corrosive substance, corrosive gas, high temperature and high humidity and direct sunshine. It causes corrosion of contact and deterioration of insulation performance of housing, etc., so that it causes motion defect of appliances.
- Do not apply external load to E&T's wire to board connector, processing process product and processing product . Deformation and breakage, etc. occur, and it causes performance defect of.
- There may be slight differences in the housing coloring, but there will be no influence on the product's performance.
- Please do not conduct any "washing process" on the connector because it may damage the product's function.
- E&T's wire to board connector is not designed for the mating and unmating of the connectors to be performed under the condition of an active electrical circuit. It may cause a spark and product defect if the connectors are mated and unmated in this way.

### 2. Instructions of On-board connector when mounting on P.C.B.

- Please beware not to add the excessive force to connector before mounting. that might cause break and soldering failure.
- Do not to touch the product tail part or nail part with bare hands. that might cause contact failure.
- The well result of mounting depends on the condition of reflow temperature, solder and so on. In order to prevent from mounting failure, please be sure to evaluate mounting. The connectors should be arranged with flat surface in order that stress by P.C.B. bow or deflection is not added to product soldering part.
- That might cause soldering crack by soldering failure and aging stress. ( fig. 2-1/2-2)

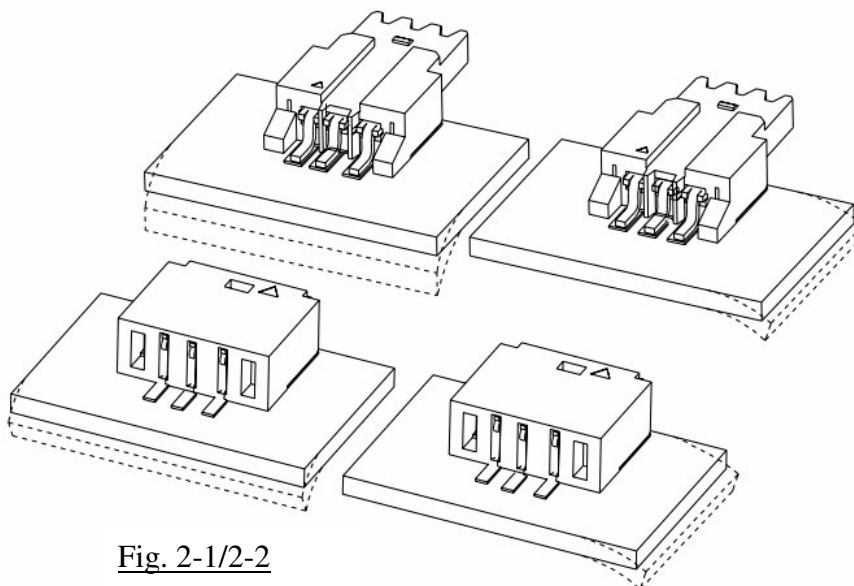

Fig. 2-1/2-2

# ENTERY INDUSTRIAL CO., LTD.

- When P.C.B. is cut into multiple P.C.B. or fastened with screw after mounting, in order that stress is not added to soldering part, please be careful to put it away from edge or screw not to interfere each other ( fig. 2-3/2-4)

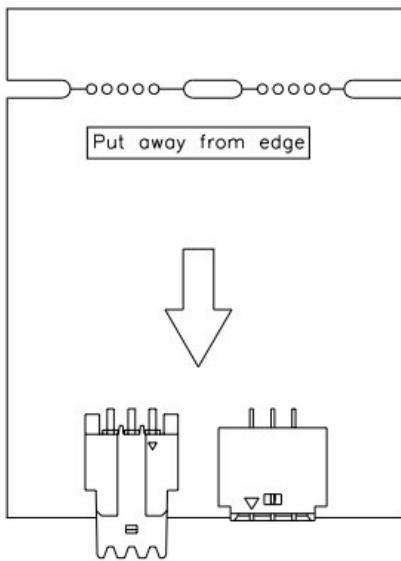

Fig. 2-3

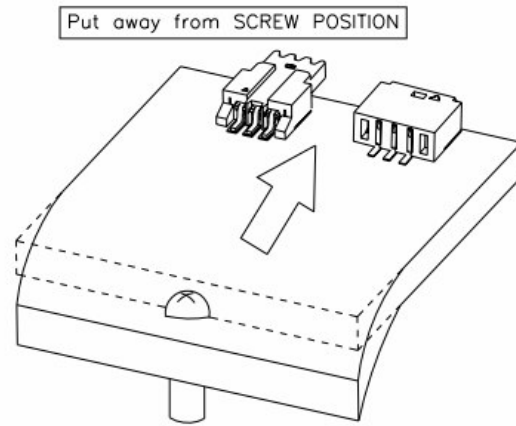

Fig. 2-4

- Please beware that the bottom dead center of vacuum nozzle and nozzle pressure when mounting. If nozzle position is too low or too much nozzle pressure is added, too much stress is added to product and that might cause soldering failure by transformation of tail part, nail part and thin part or bow of P.C.B. ( fig. 2-5)

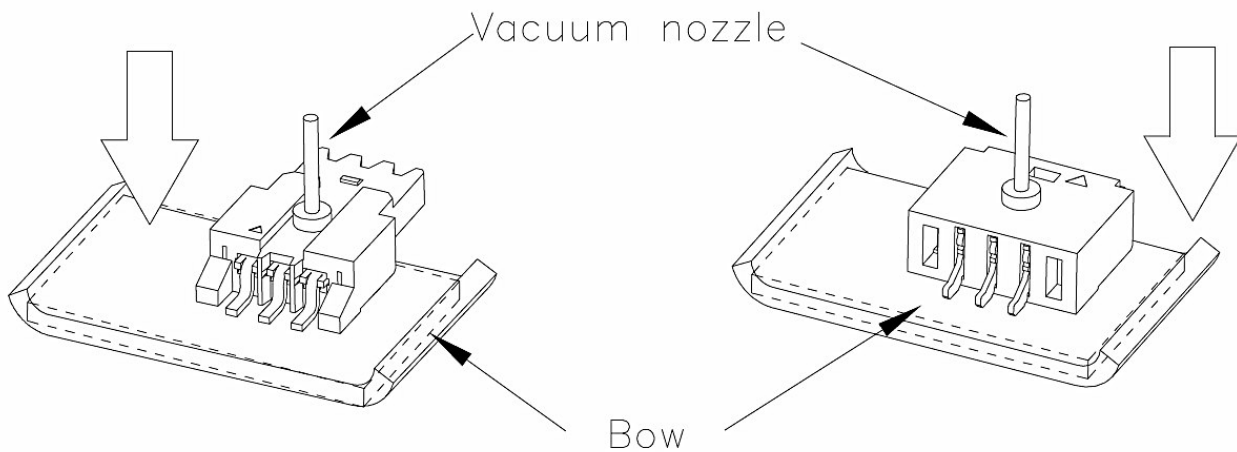

Fig. 2-5

## 3. Suggestion when mating and un-mating with On-board connectors

### 3-1. Mating method

- The mating procedure of the on-board connectors is shown as follows. Please hold P.C.B then mating them straightly and smoothly. Do not withdraw at an angle, that might cause the transformation of terminal and housing etc.

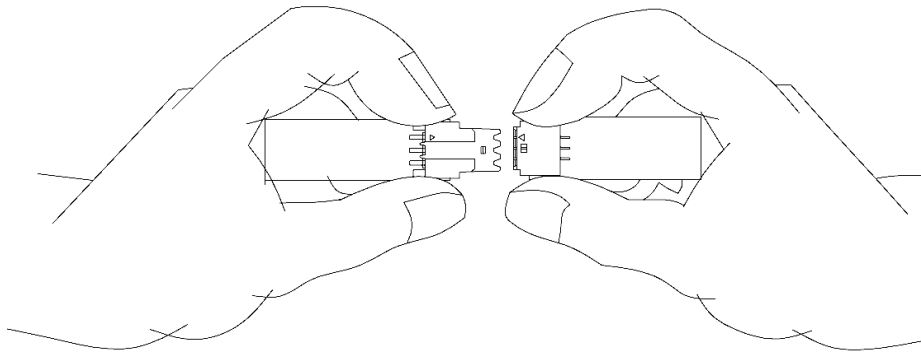

Fig. 3-1-1

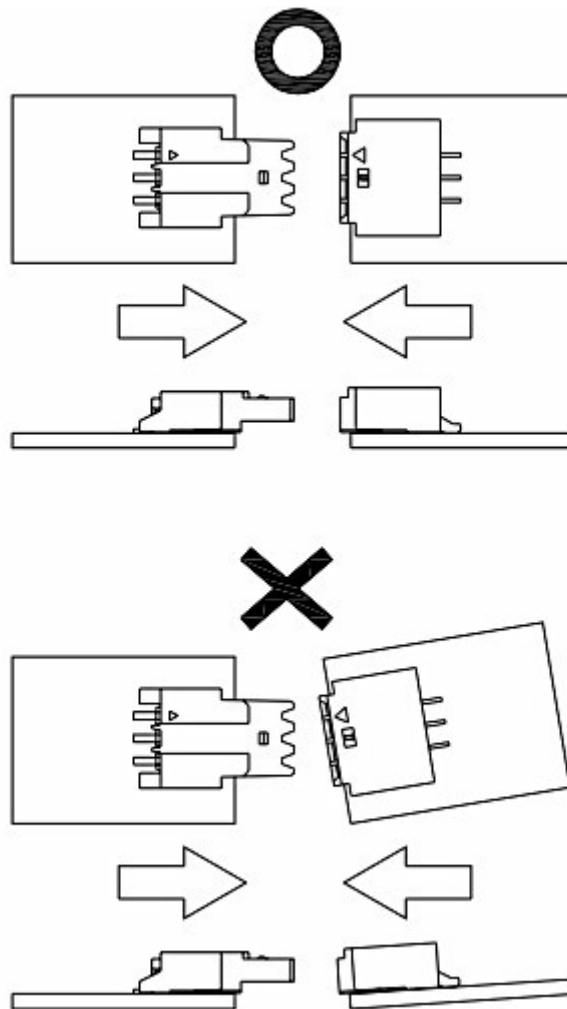

Fig. 3-1-2

### **Instruction**

- Please make sure the connectors direction are both straight while you are mating it, until they strike each other. If you mating at an angle, that might cause the transformation of terminal and housing etc. (Fig.3-1-2)
- Please make sure the connectors direction are both straight while you are mating it, until they strike each other. If you stop mating in the middle of mating, that might cause the state un-connecting.

# ENTERY INDUSTRIAL CO., LTD.

- 3-2. Check the mating state.

Please check the insert condition is straight until they strike each other.

If you stop mating in the middle of mating, that might cause the state un-connecting.

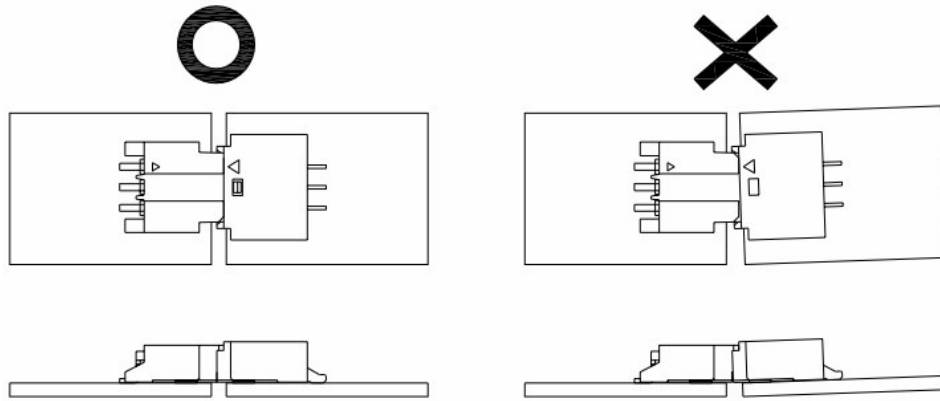

Fig. 3-2-1

- 3-3. Un-mating method.

The un-mating procedure of both BTB connectors is shown as follows.

Please hold Plug P.C.B, withdraw them straight and smoothly. (Fig.3-3-1)

Do not withdraw with angle, which might cause the transformation of terminal and housing etc. (Fig.3-3-2)

Fig.3-3-1

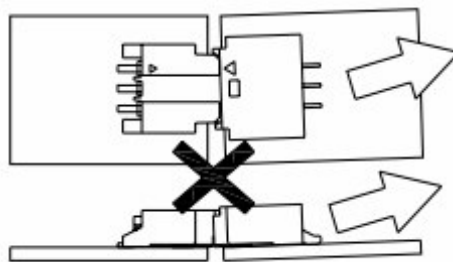
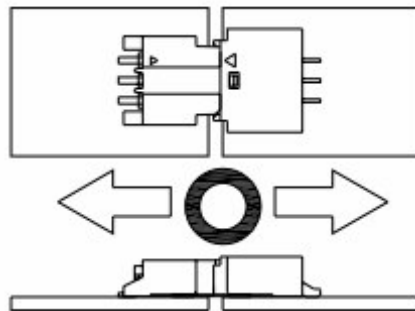
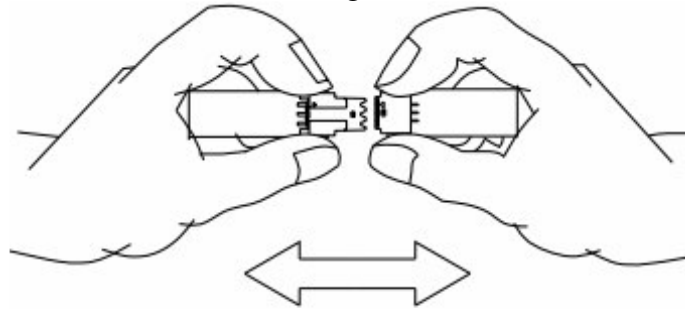

Fig. 3-3-2

# ENTERY INDUSTRIAL CO., LTD.

## ● 3-4. Application Suggestion

### Instruction

- We deeply suggest using rivet system etc. Don't mating only status.( Fig.3-4-1). If mating only, that might cause the transformation of terminal and housing etc.
- Please make sure the layout of PCB are straight with each other, do not layout angle or bump. It cause the transformation and housing etc. (Fig. 3-4-2)

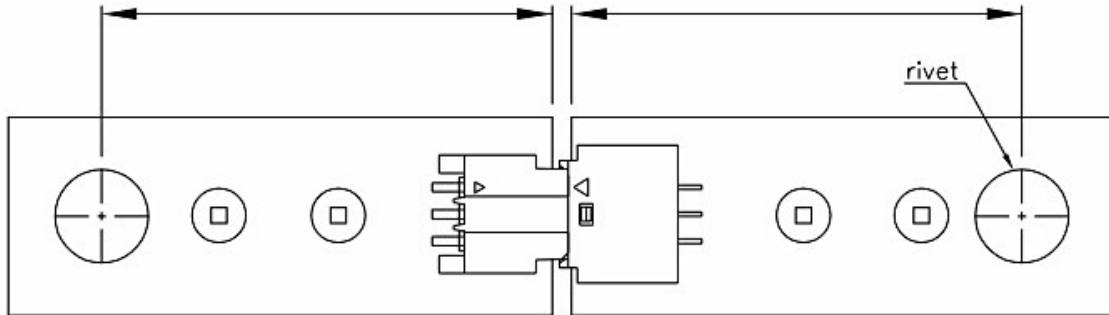

Fig. 3-4-1. (Ref.)

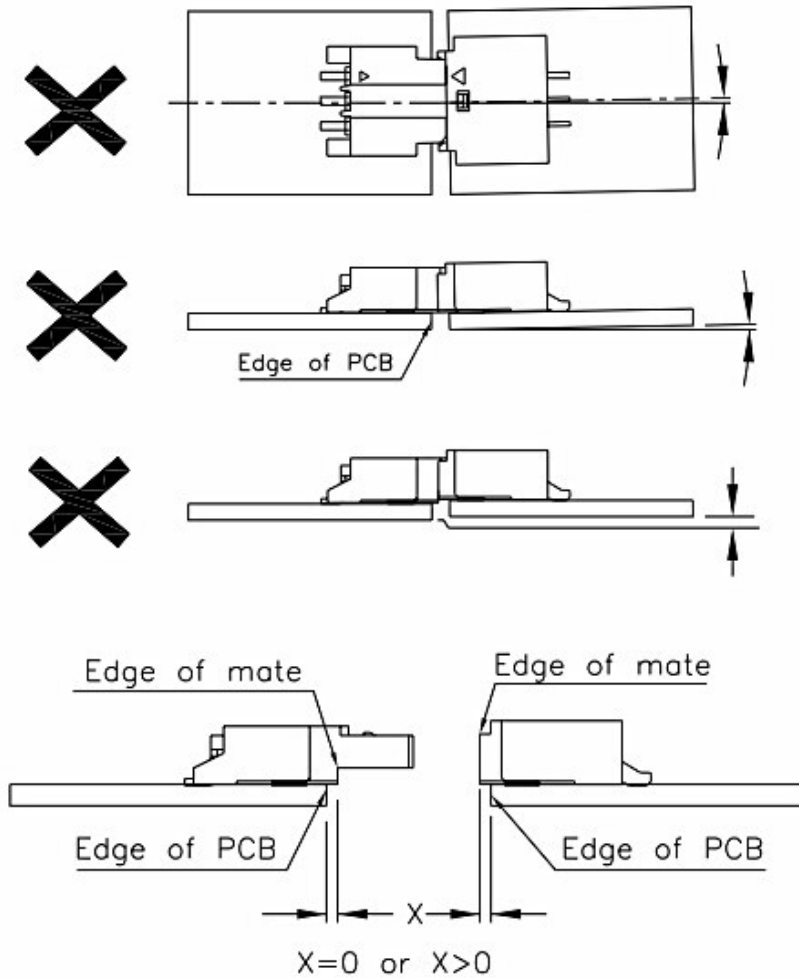

Fig. 3-4-2.

# ENTERY INDUSTRIAL CO., LTD.

## RELEASE HISTORY

<b>Rev.</b>	<b>Revisions</b>	<b>Date</b>	<b>Executor</b>	<b>Description</b>
A0	First Release	May-31-2012	Juno	First Release
A1	REN120914	Sep-18-2012	Juno	Modify UL Card
A2	REN130810	Aug-27-2013	Juno	Add mating and un mating SPEC
A3	RE201408007	Sep-01-2014	Juno	Modify copper alloy Card