

TO

SPECIFICATION FOR APPROVAL

DESCRIPTION: Pitch 1.00mm ZIF (Back-Flip Actuator) , Double Contact R/A, SMT Type H1.0

CUSTOMER PROD.NO/DWG.NO:

E&T PROD.NO: 6918K-XXXX-XXX

APPROVAL SHEET NO:

E&T DWG. NO./DOCUMENT: 6918K-XXXX-XXX

REV: A2

PLEASE RETURN TO US ONE COPY OF "SPECIFICATION FOR APPROVAL" WITH YOUR APPROVED SIGNATURES.

APPROVED SIGNATURES			



**ENTERY INDUSTRIAL CO., LTD.
E&T ELECTRONICS (DONG GUAN) CO., LTD.
E&T ELECTRONICS (SU ZHOU) CO., LTD.**

ENTERY INDUSTRIAL CO., LTD.

**Title : Pitch 1.00mm ZIF ,Back-Flip Actuator Type ,
Double Contact R/A, SMT Type H1.0**

RE201505001		Title: Pitch 1.00mm ZIF ,Back-Flip Actuator Type , Double Contact R/A, SMT Type H1.0
A2	2015/5/13	This Document Contains Information That Is Proprietary To E&T And Should Not Be Used Without Written Permission
Rev	Description	
Document No.		Prepared By: Juno.Chen
6918K-XXXX-XXX		Date: 2014/1/6
		Checked By: <i>Neil</i> 2015/5/13
		Date:
		Approved By: <i>JGR</i>
		Date: 05.13.2015

ENTERY INDUSTRIAL CO., LTD.

PRODUCT SPECIFICATION

1. SCOPE :

This specification covers the ZIF FPC Connector series.

Including part number

Part Number	Title
6918K-XXXX-XXX	Pitch 1.00mm ZIF ,Back-Flip Actuator Type , Double Contact R/A, SMT Type H1.0

2. RATINGS :

Item	Standard	
Rated Current	0.5A	AC(rms)/DC
Rated Voltage	50V	
Operating and Non-operating Temperature Range	-55 ⁰ C ~ +85 ⁰ C*	
Operating and Non-operating Humidity Range	40%~80%	
Storage Temperature Range	-10 ⁰ C ~ +50 ⁰ C*	
Storage Humidity Range	40%~70%	

*Includes temperature rise caused by current flow.

ENTERY INDUSTRIAL CO., LTD.

PRODUCT SPECIFICATION

3.PERFORMANCE :

3- 1 Electrical Performance

Item		Test Condition	Requirement
3-1-1	Contact Resistance	Mate connectors, measure by dry circuit, 20mV MAX . 10mA EIA-364-06C	60mΩ (Max)
3-1-2	Insulation Resistance	Apply 500V ±10% DC between adjacent terminals, or terminal and ground. EIA-364-21D	500MΩ(Min)
3-1-3	Withstanding Voltage Test	Apply 250V AC(rms) for 1 minute between adjacent terminals, or terminal and ground. EIA-364-20D	No Breakdown

3-2 Mechanical Performance

Item		Test Condition	Requirement
3-2-1	Mating and Unmating Force Test	Mating and unmating connectors at the speed rate of 25±3mm/minute. EIA-364-13D	Unmating Force (15gf xN) MIN N=Number of Contacts 15gf / per pin
3-2-2	Terminal/ Housing Retention Force	Apply axial pull out force at the speed rate of 25±3 mm/minute on the terminal assembled in the housing. EIA-364-29C	60 gf (Min)
3-2-3	Fitting Nail/ Housing Retention Force	Apply axial pull out force at the speed rate of 25±3 mm/minute on the fitting nail assembled in the housing. EIA-364-29C	70 gf (Min)
3-2-4	Durability	When mated up to 20 cycles repeatedly by the rate of 10 cycles/minute. EIA-364-09C	Withstanding Voltage : Meet 3-1-3
			Insulation esistance : ≥ 100MΩ
			Unmating Force (15 gf xN) MIN N=Number of Contacts
			Contact Resistance ≤ 80mΩ

ENTERY INDUSTRIAL CO., LTD.

PRODUCT SPECIFICATION

3-3 Environmental Performance and Others

Item		Test Condition	Requirement
3-3-1	Vibration	Mate connectors and subject to the following vibration conditions, for a period of 2 hours in each of 3 mutually perpendicular axes, passing DC 1mA during the test. Amplitude : 1.52mm P-P Frequency : 10-55-10 Hz Shall be traversed in 1 minute. EIA-364-28E	Appearance No Damage
			Contact Resistance $\leq 80m\Omega$
			Discontinuity 1μsec MAX
3-3-2	Temperature Life Test (Heat Resistance)	Mate connectors and expose to $85\pm 2^{\circ}C$ for 96 hours. Upon completion of the exposure period, the test specimens shall be conditioned at ambient room conditions for 1 to 2 hours, after which the specified measurements shall be performed. EIA-364-17B	Appearance No Damage
			Contact Resistance $\leq 80m\Omega$
3-3-3	Thermal Shock (Temperature Cycling Test)	Mate connectors and subject to the following conditions for 5 cycles. Upon completion of the exposure period, the test specimens shall be conditioned at ambient room conditions for 1 to 2 hours, after which the specified measurements shall be performed. 1 cycle a) $-55 +0/-3^{\circ}C$, 30 minutes(Min) b) $25 +10/-5^{\circ}C$, 5 minutes(Max) c) $85 +3/-0^{\circ}C$, 30 minutes(Min) d) $25 +10/-5^{\circ}C$, 5 minutes(Max) EIA-364-32E	Appearance No Damage
			Contact Resistance $\leq 80m\Omega$
3-3-4	Cold Resistance (Low Temperature Test)	Mate connectors and expose to $-40\pm 3^{\circ}C$ for 96 +5/-0 hours. Upon completion of the exposure period, the test specimens shall be conditioned at ambient room conditions for 1 to 2 hours, after which the specified measurements shall be performed. EIA-364-59A	Appearance No Damage
			Contact Resistance $\leq 80m\Omega$
3-3-5	Humidity	Mate connectors and expose to $40\pm 2^{\circ}C$, relative humidity 90 to 95% for 96 hours. Upon completion of the exposure period, the test specimens shall be conditioned at ambient room conditions for 5 hours, after which the specified measurements shall be performed. EIA-364-31B	Appearance No Damage
			Withstanding Voltage : Meet 3-1-3
			Insulation esistance : $\geq 100M\Omega$
			Contact Resistance $\leq 80m\Omega$

ENTERY INDUSTRIAL CO., LTD.

PRODUCT SPECIFICATION

3-3 Environmental Performance and Others

Item		Test Condition	Requirement
3-3-6	Resistance To Soldering Heat	Soldering iron method Solder Time : 3±0.5 sec Solder Temperature: 350±10℃ However, without too much pressure to the terminal pin. EIA-364-56D	Appearance No Damage
		Using the reflow profile condition below paragraph 4-1. The product was reflowed two times.	Appearance No Damage
3-3-7	Steam Aging	Steam Aging Temperature : 98±2 °C Duration: 8 hours±5 minutes Solder Temperature : 245±3 °C	Appearance No Damage
3-3-8	Solder Ability	Soldering Time : 3±0.5 sec EIA-364-52A	Solder Wetting : 95% Of Immersed Area Must Show No Voids, Pin Holes
3-3-9	Salt Spray	Mate connectors and expose to the following salt mist conditions. Upon completion of the exposure period, salt deposits shall be removed by a gentle wash or dip in running water, after which the specified measurements shall be performed. NaCl solution : 5 % Ambient temperature : 35+1/-2℃ Spray time : 48 hours This test only gold-plated products EIA-364-26B	Appearance No Damage
			Contact Resistance ≤ 80mΩ
3-3-10	Temperature Rise Test	Carrying rated current load. EIA-364-70B	Temperature Rise : 30 °C (MAX)
3-3-11	Mechanical Shock (Physical Shock)	Mate connectors and subject to the following shock conditions. 3 shocks shall be applied along 3 mutually perpendicular axes, passing DC 1 mA current during the test. (Total of 18 shocks) Test pulse : Half Sine Peak value : 490 m/s ² {50 G} Duration : 11 ms EIA-364-27B	Appearance No Damage
			Contact Resistance ≤ 80mΩ
			Discontinuity 1μsec MAX
3-3-12	SO ₂ Gas Mixed Flowing GAS Test	24 hours exposure to 50±5ppm. SO ₂ gas at 40±2℃ EIA-364-65A	Appearance No Damage
			Contact Resistance ≤ 80mΩ
3-3-13	NH ₃ Gas Mixed Flowing GAS Test	40 minutes exposure to NH ₃ gas evaporating from 28% Ammonia solution. EIA-364-65A	Appearance No Damage
			Contact Resistance ≤ 80mΩ

ENTERY INDUSTRIAL CO., LTD.

PRODUCT SPECIFICATION

4-1 Infrared Reflow Condition

- 1) Ascending time to preheating temperature 170°C shall be 40 seconds minimum.
- 2) Preheating shall be fixed at 160...180°C for 60...90 seconds.
- 3) Heating shall be fixed at 220°C for 50...60 seconds.
- 4) At 260±5°C peak shall be 10 seconds maximum.

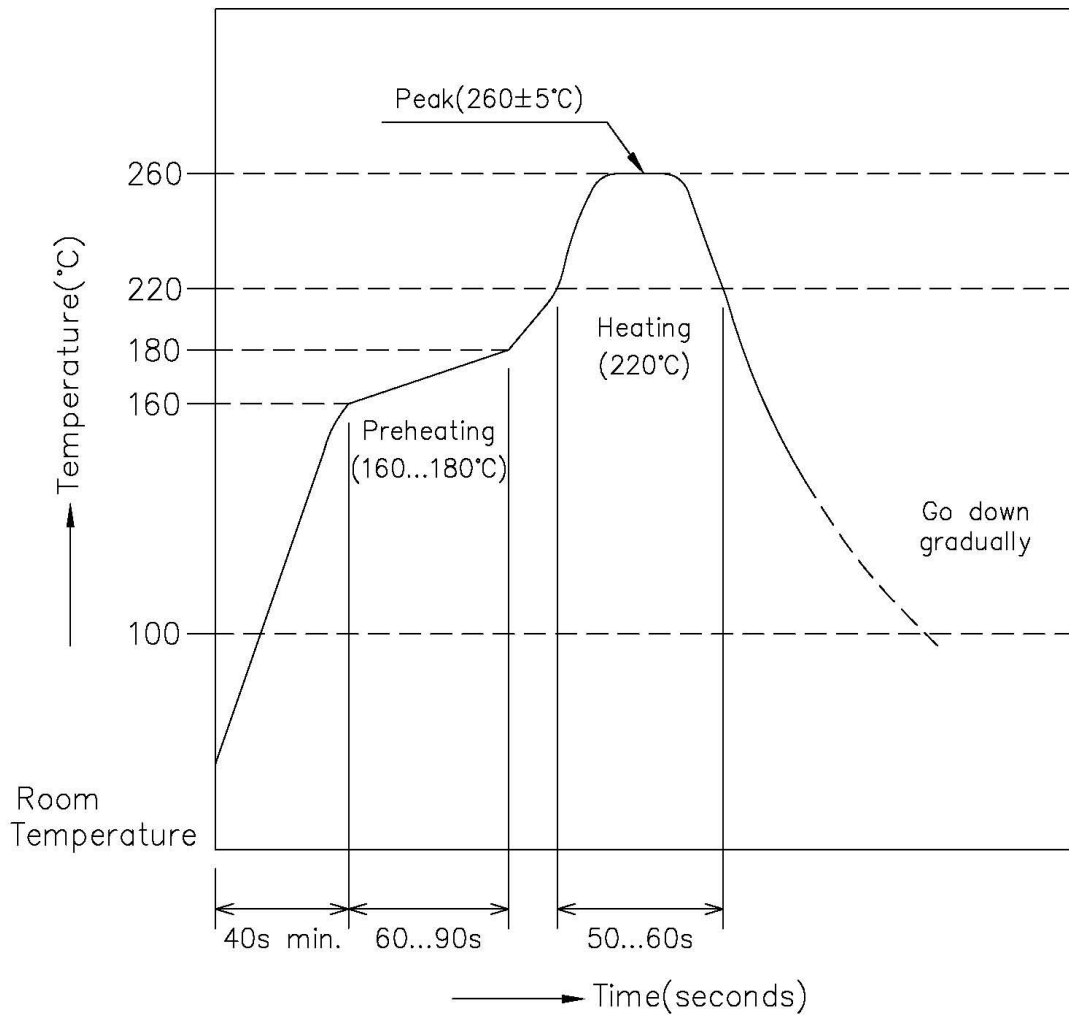

FPC /FFC Connector Back Flip Lock Type Handling Precautions

This manual is to describe basic precautions. When there are doubtful points in use of, please contact E&T.

1. Common Handling Precautions

- Do not expose E&T's ZIF FPC/FFC connector, processing process product and processing product to corrosive substance, corrosive gas, high temperature and high humidity and direct sunshine. It causes corrosion of contact and deterioration of insulation performance of housing, etc., so that it causes motion defect of appliances.
- Do not apply external load to E&T's ZIF FPC/FFC connector, processing process product and processing product . Deformation and breakage, etc. occur, and it causes performance defect of.
- There may be slight differences in the housing coloring, but there will be no influence on the product's performance.
- Please add a stiffener on the flexible printed circuit (FPC/FFC) when you mount the connector onto FPC in order to prevent deformation of the FPC/FFC.
- Please do not conduct any "washing process" on the connector because it may damage the product's function.

2. PC Board Precautions

- Exercise caution when handling boards with the connectors installed. Do not apply any forces affecting soldered joints. (see figure 1).
- The mounting specification for coplanarity does not include the influence of warpage of the printed circuit board. (see figure 1).

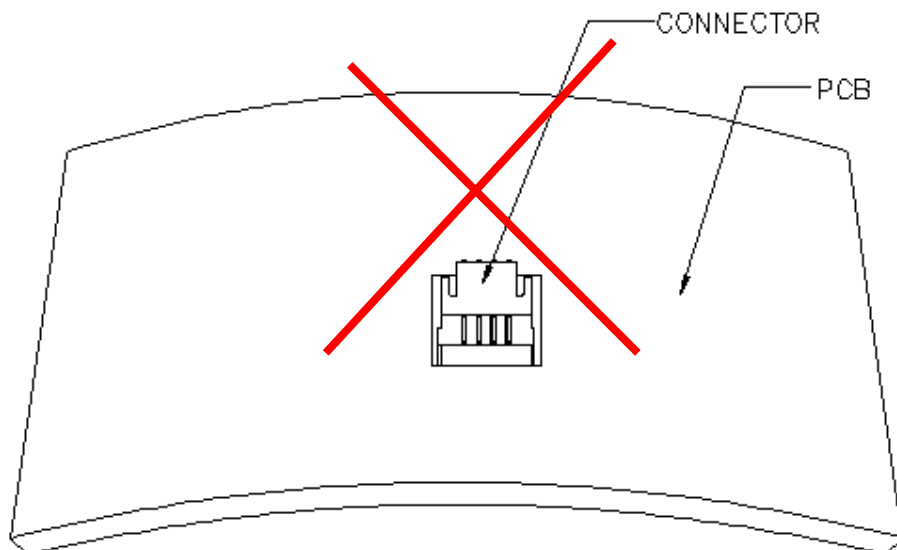

Figure 1.

3. Operation

FPC/FFC Insertion Procedure.

- 1) Connector installed on the board.
Lift up the actuator(Lock). Use thumb or index finger. (see figure 2).

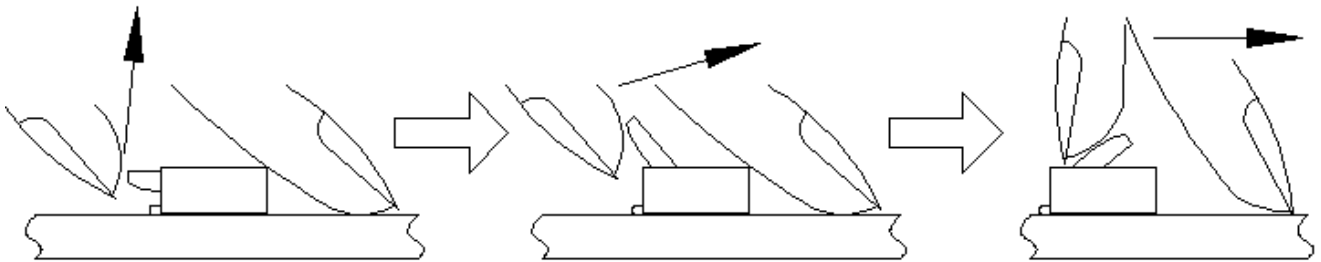

Figure 2.

- 2) Assure that the FPC/FFC is fully inserted parallel to mounting surface, with the exposed conductive traces facing down. (see figure 3).

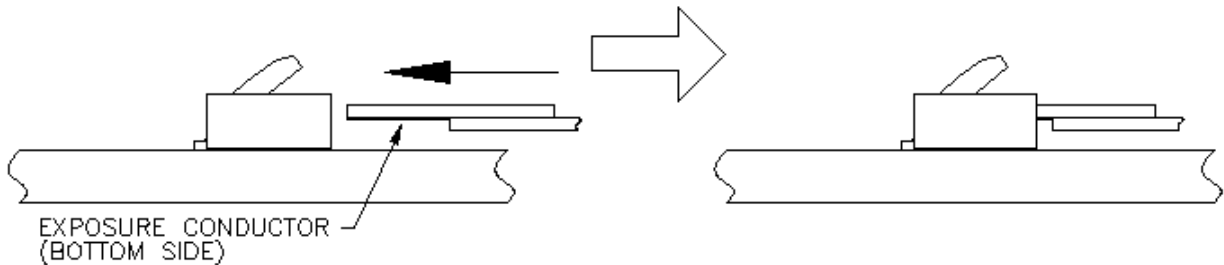

Figure 3.

- 3) Rotate down the actuator(Lock) until firmly closed. It is critical that the inserted FPC is not moved and remains fully inserted. Should the FPC be moved, open the actuator(Lock) and repeat the process, starting with Step 1(see figure 4).

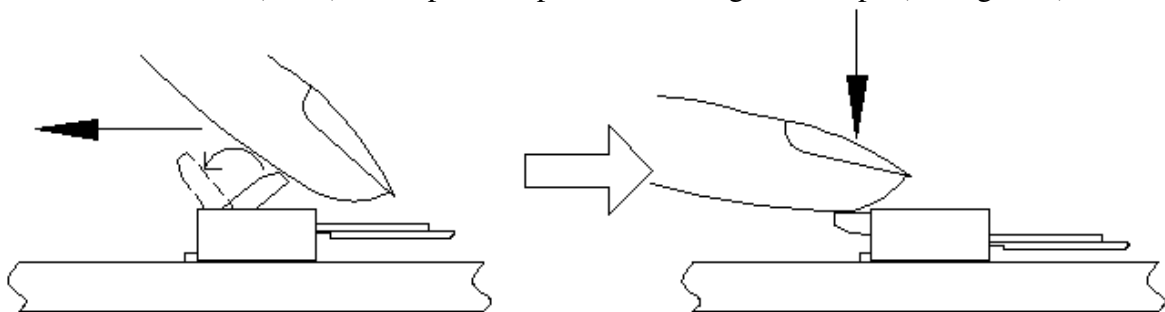

Figure 4.

FPC/FFC Removal.

- 1) Lift up the actuator(Lock). Carefully withdraw the FPC/FFC. (see figure 5).

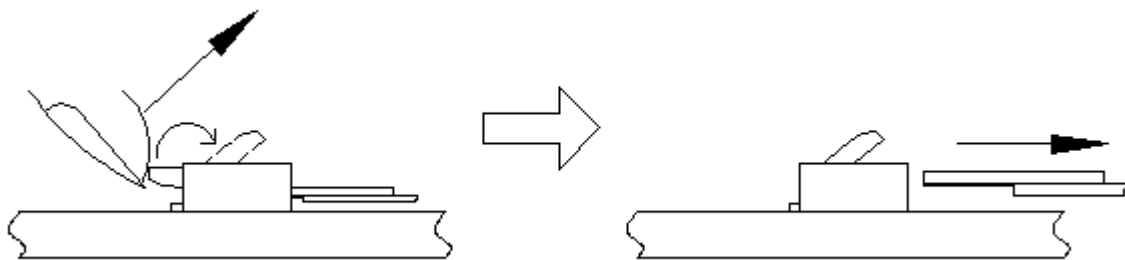

Figure 5.

ENTERY INDUSTRIAL CO., LTD.

4. Precautions When Inserting or Withdrawal FPC/FFC

- FPC/FFC to be insertion and withdrawal at an angle of about 15° , and the FPC/FFC should be inserted firmly all the way to the back. (see figure 6).

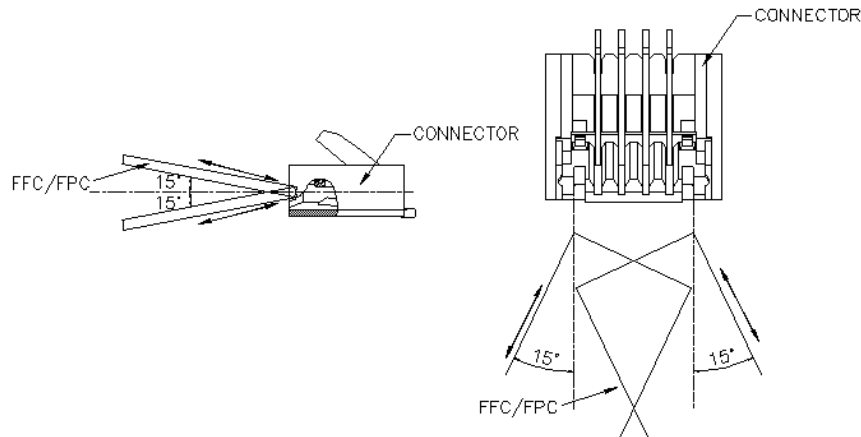

Figure 6.

- Do not apply excessive force or use any type of tool to operate the actuator(Lock).
- When locking the actuator(Lock), please make sure that the actuator is entirely closed by pressing on the entire actuator. Pushing the one specific point of the actuator may cause the actuator to be detached or damaged. When locking the longer actuator(Lock), please use two points to put pressure on locking. (see figure 7).

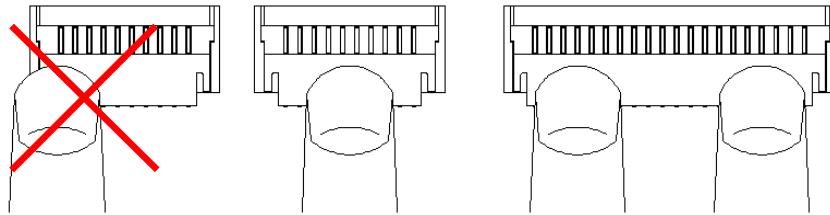

Figure 7.

- The connector will assure reliable performance when the actuator is open to an angle (please refer to drawing) maximum. Do not exceed this angle, as this may cause permanent damage to the connector. (see figure 8)
- Avoid grasping the actuator(Lock) with two fingers or lifting the actuator(Lock) with fingernail. (see figure 8)
- Do not apply force in the direction of arrows. Doing this may cause the actuator to be detached or damaged. (see figure 8).
- Do not close the actuator without the FPC/FFC inserted. (see figure 8)

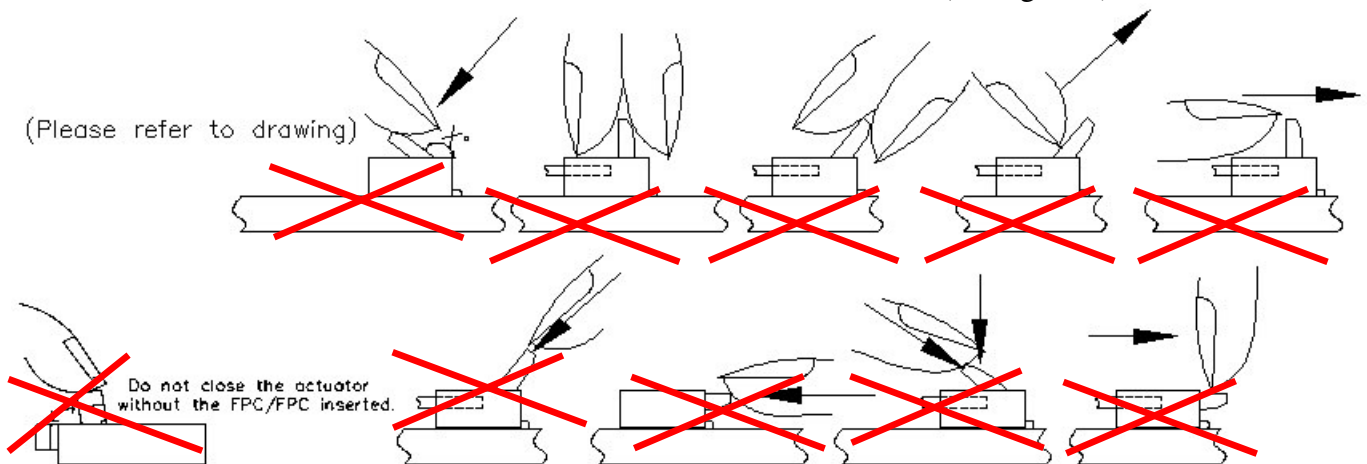

Figure 8.

ENTERY INDUSTRIAL CO., LTD.

- When inserting the FPC/FFC, do not forcefully rub against the surface beneath the connector insertion slot. Doing so will result in the FPC/FFC forcefully striking the contacts and this will cause contact deformation, peeling of the FPC/FFC conductors, and other irregularities. (see figure 9).

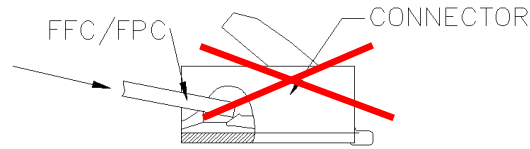

Figure 9.

- Do not apply any forces affecting soldered joints. Do not apply upward pull-force to the FPC/FFC close to the connector. (see figure 10).
- If necessary, please fix the FPC/FFC directly on the chassis. Also, please avoid pulling the FPC/FFC vertically or twisting the FPC back and force horizontally while it is inserted in the connector(see figure 10).
- Forming processing is conducted to FPC so as not to load force to connector. (see figure 10).

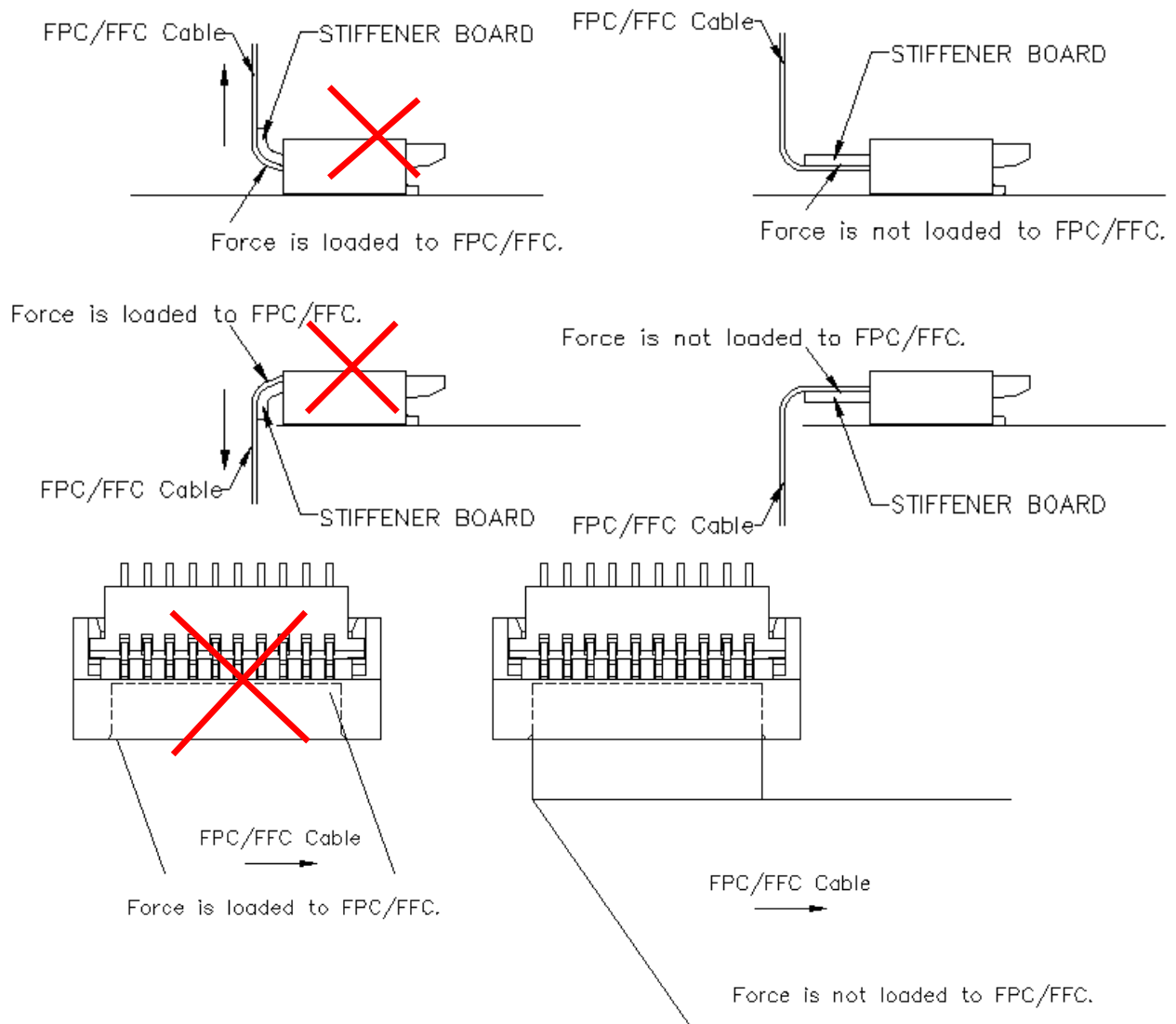

Figure 10.

ENTERY INDUSTRIAL CO., LTD.

RELEASE HISTORY

Rev.	Revisions	Date	Executor	Description
A0	RB131201	JAN-06-2014	Juno	First Release
A1	RE201405006	MAY-29-2014	NEIL	Modify PIN Retention Force
A2	RE201505001	MAY-13-2015	Juno	Modify UL